







Prese ad Innesto Rapido - Quick Couplings - Schnellverschluss Kupplungen - Coupleurs Automatiques - Enchufes Rápidos - Conexões de Engate Rápido

<p>SERIE UNI ISO 6150 A-6</p>  <p>Serie 100 Pag. 16.7 - 16.10</p>	<p>SERIE MIGNON</p>  <p>Serie 110 Pag. 16.11 - 16.16</p>	<p>SERIE UNI ISO 6150 B-12</p>  <p>Serie 120 Pag. 16.17 - 16.22</p>	<p>ITALIAN PROFILE</p>  <p>Serie 120 Pag. 16.23 - 16.28</p>
<p>SERIE UNI ISO 6150 B-15</p>  <p>Serie 130 Pag. 16.29 - 16.33</p>	<p>SERIE UNI ISO 6150 C-10</p>  <p>Serie 140 Pag. 16.34 - 16.39</p>	<p>EUROPEAN PROFILE</p>  <p>Serie 160 Pag. 16.40 - 16.45</p>	<p>SWISS PROFILE</p>  <p>Serie 170 Pag. 16.46 - 16.50</p>
<p>MIGNON PROFILE</p>  <p>Serie 180 Pag. 16.51 - 16.54</p>	<p>MULTISOCKET</p>  <p>Serie 190 - 63190 Pag. 16.55 - 16.61</p>	<p>JAPANESE PROFILE</p>  <p>Serie 400 Pag. 16.62 - 16.64</p>	<p>MINI DN 2,7</p>  <p>Serie 700 Pag. 16.65 - 16.67</p>
<p>SERIE UNI ISO 6150 B-17</p>  <p>Serie 710 Pag. 16.68 - 16.70</p>	<p>B-SOCKET EUROPEAN</p>  <p>Serie 720 Pag. 16.71 - 16.74</p>	<p>EUROPEAN PROFILE</p>  <p>Serie 730 Pag. 16.75 - 16.80</p>	<p>EUROPEAN PROFILE</p>  <p>Serie 740 Pag. 16.81 - 16.83</p>

Prese di Sicurezza ad Innesto Rapido - Safety Quick Couplings - Kupplungen Sicherheit - Coupleurs de Sécurité - Enchufes de Seguridad - Conexões de Segurança

<p>SERIE UNI ISO 6150 B-12</p>  <p>Serie 620 Pag. 16.85 - 16.88</p>	<p>ITALIAN PROFILE</p>  <p>Serie 650 Pag. 16.89 - 16.90</p>	<p>EUROPEAN PROFILE</p>  <p>Serie 660 Pag. 16.91 - 16.92</p>	<p>SWISS PROFILE</p>  <p>Serie 670 Pag. 16.93 - 16.94</p>
<p>SERIE UNI ISO 6150 B-12</p>  <p>Serie OB120 Pag. 16.97 - 16.99</p>	<p>SERIE UNI ISO 6150 C-10</p>  <p>Serie OB140 Pag. 16.100 - 16.102</p>		

Giunti ad Innesto Rapido per Raffreddamento Stampi - Quick Couplings for Molding Cooling - Schnellkupplungen für Spritzgussanwendungen - Coupleurs pour Moules D'injection - Enchufes Rápidos para Refrigeración de Moldes - Conexões de Engate Rápido para Resfriamento de Moldes

<p>FRENCH PROFILE DN 8 - DN 12</p>  <p>Series 410 - 420 - 510 - 520 Pag. 16.104 - 16.110</p>	<p>INTERNATIONAL PROFILE DN 6 - DN 9</p>  <p>Series 430 - 440 - 530 - 540 Pag. 16.112 - 16.119</p>	<p>EUROPEAN PROFILE DN 6 - DN 9</p>  <p>Series 460 - 470 - 560 - 570 Pag. 16.120 - 16.127</p>	<p>6049</p>  <p>Pag. 16.128</p>
---	---	---	---

Pistole di Soffiaggio - Blow Guns - Blaspistolen - Soufflettes - Pistolas Sopladoras - Pistola de Ar

<p>Series 360</p>  <p>Pag. 16.130 - 16.131</p>	<p>Series 300</p>  <p>Pag. 16.133 - 16.135</p>	<p>Spare Parts</p>  <p>Pag. 16.136</p>	<p>Series 340</p>  <p>Pag. 16.137 - 16.138</p>
--	--	---	--

Aignep si riserva il diritto di variare modelli e ingombri senza preavviso - Aignep reserves the right to vary models and dimensions without notice - Aignep behält sich das Recht vor, Daten ohne Ankündigung zu ändern
 Aignep se reserva el derecho de modificar modelos y dimensiones sin previo aviso - Aignep reserva-se o direito de alterar os modelos e dimensões sem prévio aviso

GIUNTI AD INNESTO RAPIDO E PISTOLE AD ARIA

AUTOMATIC QUICK COUPLINGS AND BLOW GUNS

SCHNELLVERSCHLUSS-KUPPLUNGEN UND BLASPISTOLEN

COUPLEURS AUTOMATIQUES ET SOUFFLETTES





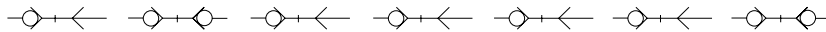

ENCHUFES RÁPIDOS Y PISTOLAS DE AIRE

CONEXÕES DE ENGATE RÁPIDO E PISTOLAS DE AR

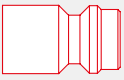
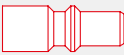
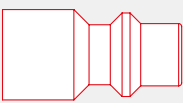
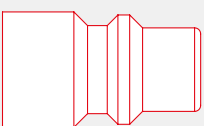
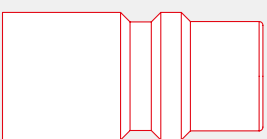
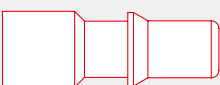
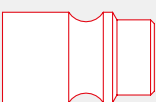
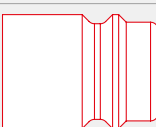
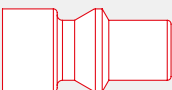
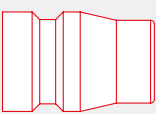
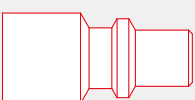

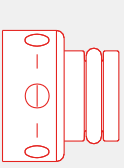
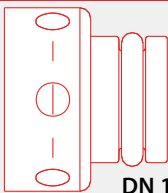
Serie Quick Couplings

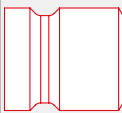
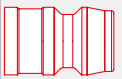

PLUG PROFILE 1:1	STANDARD	SINGLE SHUT OFF	DOUBLE SHUT OFF	STANDARD	MULTI	SAFETY	INOX	DOUBLE SHUT OFF
	DN 5 MIGNON	210 Pag. 15.11	280 Pag. 15.51	110 Pag. 15.11				180 Pag. 15.51
	DN 2.5 UNI-ISO 6150-A6	200 Pag. 15.7		100 Pag. 15.7				
	DN 5.5 UNI-ISO 6150-B12 INDUSTRIAL 1/4	220 Pag. 15.17		120 Pag. 15.17	190 Pag. 15.55	620 Pag. 15.87 OB120 Pag. 15.97		
	DN 9 UNI-ISO 6150-B15 INDUSTRIAL 3/8	230 Pag. 15.29		130 Pag. 15.29	720 Pag. 15.71			
	DN 12 UNI-ISO 6150-B17 INDUSTRIAL 1/2	810 Pag. 15.68		710 Pag. 15.68				
	DN 5.5 UNI-ISO 6150-C10	240 Pag. 15.34		140 Pag. 15.34		OB140 Pag. 15.100		
	DN 7.5 - 7.8 EUROPEAN	260 63260 Pag. 15.40 Pag. 15.59	840 Pag. 15.81	160 Pag. 15.40 730 Pag. 15.75	190 Pag. 15.55	660 Pag. 15.91	63190 Pag. 15.59	740 Pag. 15.81
	DN 10 EUROPEAN DN 10	820 Pag. 15.71		720 Pag. 15.71				
	DN 5.5 SWISS	270 Pag. 15.46		170 Pag. 15.46	190 Pag. 15.55	670 Pag. 15.93		
	DN 7.5 JAPANESE	500 Pag. 15.62		400 Pag. 15.62				
	DN 5 ITALIAN	250 Pag. 15.23		120 Pag. 15.23	190 Pag. 15.55	650 Pag. 15.89		
	DN 2.7 MINI	800 Pag. 15.65		700 Pag. 15.65				
	DN 8 FRENCH	510 Pag. 15.106		410 Pag. 15.106				
	DN 12 FRENCH	520 Pag. 15.109		420 Pag. 15.109				
	DN 6 INTERNATIONAL	530 Pag. 15.114		430 Pag. 15.114				
	DN 9 INTERNATIONAL	540 Pag. 15.117		440 Pag. 15.117				
	DN 6 EUROPEAN	560 Pag. 15.122		460 Pag. 15.122				
	DN 9 EUROPEAN	570 Pag. 15.125		470 Pag. 15.125				

AIR

WATER / OIL

RECTUS/LEGRIS PARKER 21/90	CAMOZZI 5050 - 5150	CEJN 220		FESTO KD - KS 3		
RECTUS/PARKER 21/90	CAMOZZI 5050 - 5150	CEJN 200				
				FESTO KD - KS 2		
RECTUS/LEGRIS 23/24 PARKER 20/30 - 1/4 TEMA 1400	HANSEN 3000	CEJN 310	INDUSTRIAL 1/4	GROMELLE 600	US - MIL SPEC C-4109	
RECTUS/LEGRIS 30 PARKER 30 - 3/8	HANSEN 4000	CEJN 430	INDUSTRIAL 3/8	GROMELLE 900	US - MIL SPEC C-4109	
RECTUS 37	HANSEN 5000	CEJN 550		GROMELLE 1300	US - MIL SPEC C-4109	
RECTUS/LEGRIS 18			AIR			
RECTUS/LEGRIS 25/26/1600/1625 TEMA 1600	CAMOZZI 5080 - 5180	CEJN 320			FESTO KD - KS 6 KD - KS 4	
RECTUS/LEGRIS 27		CEJN 410				
RECTUS/LEGRIS 14/22 PARKER 50	HANSEN 210	CEJN 300		ARO 210		
RECTUS/LEGRIS 13	SMC KK130	CEJN 315	NITTO KOHKI 200			
RECTUS/LEGRIS PARKER 20/91				FESTO KD - KS 2		
RECTUS 608			WATER / OIL			
RECTUS 612						
RECTUS 86	DME 1/4					
RECTUS 87	DME 3/8					
RECTUS 10	HASCO Z80/811HT/9 [Øe 9]	CEJN 220 - 221 - 225				
RECTUS 11	HASCO Z80/811HT/13 [Øe 13.5]					

La gamma dei giunti ad innesto rapidi Aignep permette una risposta adeguata ai molteplici bisogni dei nostri clienti. Le differenti applicazioni, le prestazioni e l'affidabilità, sono i vantaggi dati dall'insieme di questa importantissima gamma.

A semplice o doppia intercettazione in ottone nichelato, in acciaio inox, conformi alle principali norme di riferimento possono essere utilizzati per veicolare molteplici fluidi.

A completamento pistole di soffiaggio.

Principali vantaggi

- Passaggi da DN 2,5 a 12 mm
- Profili normalizzati
- Gamme Multipresa
- Montaggio con una sola mano
- Leggerezza ed ingombro ridotto
- Versioni di sicurezza
- Raffreddamento stampi normalizzati
- Silicon Free

Applicazioni

- Impianti Aria Compressa e Strumenti
- Automazione Pneumatica e Fluidica
- Food & Beverage
- Life & Sciences
- Raffreddamento stampi
- Gas inerti, versioni per vuoto

Aignep range of quick couplings is able to satisfy multiple needs of our customers.

Wide variety of models: single & double shut-off, multisocket, safety.

The most popular profiles and nominal diameters available in nickel-plated brass and stainless steel.

For compressed air and for moulding injection cooling system.

To complete the line a wide range of air blow guns.

Main advantages

- DN 2,5 - 12 mm
- Standard profiles
- Multisocket
- Single handed operation
- Light and compact
- Safety version
- Moulding couplers
- Silicon Free

Applications

- Compressed Air & Tools
- Pneumatic & Fluidtechnology
- Food & Beverage
- Life & Sciences
- Cooling System
- Inert Gases, Vacuum

Die Schnellverschlusskupplungs-Serie von Aignep antwortet auf die vielfältigen Bedürfnisse unserer Kunden. Zahlreiche verschiedene Modelle: Einzel- und Doppelabspernung, Mehrfachstecker, Sicherheitskupplungen.

Die beliebtesten Profile und Nennweiten sind aus vernickeltem Messing und Edelstahl verfügbar.

Für Druckluft und für Spritzguss-Kühlsysteme. zu formen. Zur Vervollständigung der Serie eine große Auswahl an Blaspistolen.

Hauptvorteile

- DN 2,5 - 12 mm
- Standard Profile
- Mehrfachstecker
- Einhändige Bedienung
- Leicht und kompakt
- Sicherheits Versionen
- Spritzwerkzeug-Kühlung
- Silikonfrei

Anwendungen

- Druckluft & Werkzeuge
- Pneumatik und Fluidtechnik
- Lebensmittel & Getränke
- Life Science
- Kühlsysteme
- Inertgase, Vakuum

FR

Les coupleurs rapides Aignep répondent à de nombreuses utilisations. Grande variété de modèles en version simple et double obturation, multiprise, de sécurité. Les profils et les diamètres nominaux les plus courants sont disponibles en laiton nickelé et acier inoxydable 316L.

Pour air comprimé et tous fluides industriels ainsi qu'une gamme dédiée pour le refroidissement des moules dans l'injection plastique. Une large gamme de soufflettes vient compléter notre offre.

Principaux avantages

- DN 2,5 - 12 mm
- Profils standards
- Multisocket
- Opération d'une seule main
- Léger et compact
- Version de sécurité
- Coupleurs pour moule
- Sans silicone

Applications

- Air comprimé
- Outillage pneumatique
- Agro alimentaire
- Sciences de la vie
- Système de refroidissement
- Gaz neutres, vide

ES

La gama de enchufes rápidos Aignep permite una respuesta adecuada a las múltiples necesidades de nuestros clientes. Las diferentes aplicaciones, las prestaciones y la fiabilidad, son las ventajas que ofrece esta importantísima gama.

A simple y doble obturación en latón níquelado, acero inox, conforme a las principales normas de referencia pueden ser utilizados para vehicular múltiples fluidos. Completan esta gama las pistolas de soplado.

Principales ventajas

- Pasos de DN 2,5 a 12 mm
- Perfiles normalizados
- Gama Multipresa
- Montaje con una sola mano
- Ligereza y reducidas dimensiones
- Versión de seguridad
- Refrigeración de moldes normalizados
- Libres de silicona

Aplicaciones

- Instalaciones de aire comprimido y herramientas
- Automatización neumática y fluidica
- Alimentos y bebidas
- Life & Science
- Refrigeración de moldes
- Gases inertes, versiones para vacío

PT

A linha de engates rápidos Aignep pode satisfazer as diferentes necessidades dos consumidores. Ampla gama: fechamento simples ou duplo, multisocket, segurança.

Os itens mais populares e diâmetros nominais estão disponíveis em latão níquelado ou aço inox.

A linha é adequada para ar comprimido e resfriamento de moldagem.

Completam a linha as pistolas de ar.

Pricipais Vantagens

- DN 2,5 - 12 mm
- Perfil-padrão
- Multisocket
- Instalação fácil - com uma só mão
- Leve e compacta
- Engate de Segurança
- Engates Resfriamento
- Livre de silicone

Aplicação

- Ar Comprimido & Ferramentas
- Pneumática & Tecnologia de Fluidos
- Alimentos e bebidas
- Life & Sciences
- Sistemas de Resfriamento
- Gases Inertes, Vácuo

SERIE 120 ITALIAN PROFILE



CARATTERISTICHE TECNICHE

TECHNICAL CHARACTERISTICS
TECHNISCHE ANGABEN
CARACTÉRISTIQUES TECHNIQUES
CARACTERÍSTICAS TÉCNICAS
CARACTERÍSTICAS TÉCNICAS



Norma di Riferimento

Reference standard
Entspricht der Norm
Norme de référence
Normativa de referencia
Norma de referència

1907/2006
REACH ✓

2011/65/CE
RoHS ✓

PED
2014/68/UE

SILICON
FREE

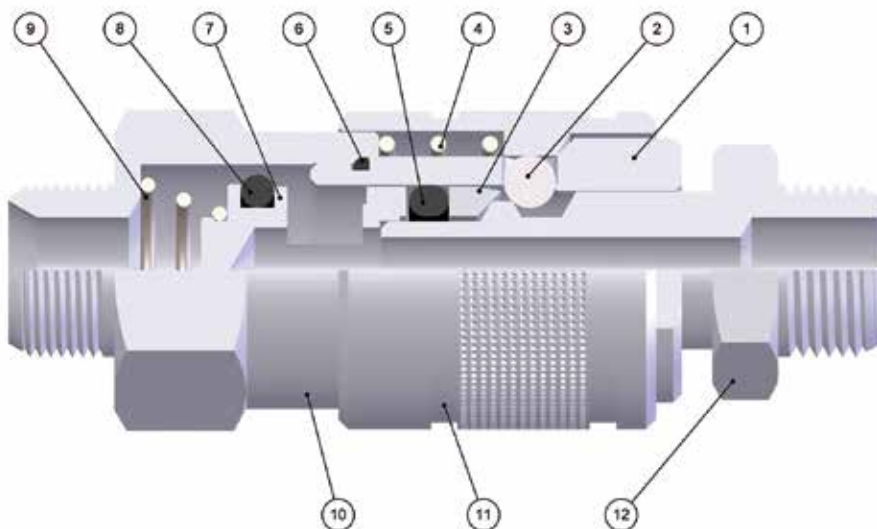

FKM A RICHIESTA
IF REQUESTED FKM
FKM AUF ANFRAGE
FKM SUR DEMANDE
FKM BAJO DEMANDA
FKM SOB ENCOMENDA

DN
5 mm

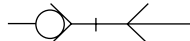

ITALIAN

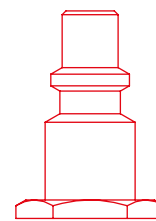

1:1

Materiali e Componenti **IT**

- 1 Corpo in Ottone Nichelato
- 2 Sfera in Acciaio AISI 420
- 3 Anello Guida Innesto in Ottone Nichelato
- 4 Molla Ghiera in Acciaio AISI 302
- 5 Guarnizione O-Ring in NBR
- 6 Guarnizione O-Ring in NBR
- 7 Otturatore in Ottone Nichelato
- 8 Guarnizione O-Ring in NBR
- 9 Molla Otturatore in Acciaio AISI 302
- 10 Attacco Terminale in Ottone Nichelato
- 11 Ghiera in Ottone Nichelato
- 12 Innesto in Ottone Nichelato

Component Parts and Materials **GB**

- 1 Nickel-Plated Brass Body
- 2 Stainless Steel AISI 420 Balls
- 3 Nickel-Plated Brass Guide Ring Coupling
- 4 Stainless Steel AISI 302 Ring Nut Spring
- 5 NBR O-Ring Seals
- 6 NBR O-Ring Seals
- 7 Nickel-Plated Brass Shutter
- 8 NBR O-Ring Seals
- 9 Stainless Steel AISI 302 Shutter Spring
- 10 Nickel-Plated Brass Coupling Back Part
- 11 Nickel-Plated Brass Sleeve
- 12 Nickel-Plated Brass Plug Outline

Komponenten und Materialien **DE**

- 1 Körper Messing Vernickelt
- 2 Kugel Edelstahl AISI 420
- 3 Stecker Führungsring Messing Vernickelt
- 4 Entriegelungsfeder Edelstahl AISI 302
- 5 O-Ring NBR
- 6 O-Ring NBR
- 7 Verschluss Messing Vernickelt
- 8 O-Ring NBR
- 9 Verschlussfeder Edelstahl AISI 302
- 10 Einschraubkörper Messing Vernickelt
- 11 Entriegelungshülse Messing Vernickelt
- 12 Stecker Messing Vernickelt

Matériaux et Composants **FR**

- 1 Corps: Laiton Nickelé
- 2 Bille: Acier Inoxydable AISI 420
- 3 Bague de Guidage: Laiton Nickelé
- 4 Ressort de Bague: Acier Inoxydable AISI 302
- 5 Joint Torique en NBR
- 6 Joint Torique en NBR
- 7 Clapet: Laiton Nickelé
- 8 Joint Torique en NBR
- 9 Ressort de Clapet: Acier Inoxydable AISI 302
- 10 Corps: Laiton Nickelé
- 11 Bague: Laiton Nickelé
- 12 Embout: Laiton Nickelé

Materiales y Componentes **ES**

- 1 Cuerpo en latón niquelado
- 2 Esfera en acero AISI 420
- 3 Anillo guía enchufe en latón niquelado
- 4 Muelle tuerca en acero AISI 302
- 5 Junta tórica en NBR
- 6 Junta tórica en NBR
- 7 Obturador en latón niquelado
- 8 Junta tórica en NBR
- 9 Muelle obturador en acero AISI 302 9
- 10 Terminal de conexión en latón niquelado
- 11 Tuerca en latón niquelado
- 12 Enchufe en latón niquelado

Materials e Componentes **PT**

- 1 Corpo em Latão Niquelado
- 2 Esfera em aço AISI 420
- 3 Anel guia do plug em latão niquelado
- 4 Mola da porca em aço AISI 302
- 5 Vedação O-Ring em NBR
- 6 Vedação O-Ring em NBR
- 7 Obturador em latão niquelado
- 8 Vedação O-Ring em NBR
- 9 Mola do obturador em aço AISI 302
- 10 Conexão terminal em latão niquelado
- 11 Porca em latão niquelado
- 12 Plug em latão niquelado



Pressione d'esercizio

Working Pressures

Betriebsdruck

Pression de service

Presión de Ejercicio

Pressão de Trabalho

0 bar
16 bar



Max pressione statica (no pulsazioni)

Maximum static pressure (no pulsations)

Maximaler statischer Betriebsdruck (ohne pulsations)

Pression statique maximale (sans pulsation)

Presión estática máxima (sin pulsaciones)

Pressão estática máxima (sem pulsações)

35 bar



Temperature

Temperatures

Temperatur

Températures

Temperaturas

Temperaturas

- 20 °C

+ 80 °C

Con O-ring in FKM

With FKM O-ring

Mit O-ring in FKM

Avec joints en FKM

Con junta tórica en FKM

Com O-ring em FKM

- 10 °C

+ 200 °C



Fluidi compatibili

Aria compressa

Fluids

Compressed air

Geeignete Medien

Druckluft

Fluides compatibles

Air comprimé

Fluidos compatibles

Aire comprimido

Fluidos compatíveis

Ar comprimido

Per altri fluidi, consultare l'ufficio tecnico Aignep.

For other fluids, consult the technical department Aignep.

Für andere Flüssigkeiten, kontaktieren Sie uns.

Pour d'autres fluides, veuillez nous consulter.

Para otros fluidos póngase en contacto con el departamento técnico Aignep.

Para outros fluidos consulte o departamento técnico da Aignep.



Portata

NI/min

Flow Rate

Durchflusswerte

Débit

Caudal de Flujo

Vazão

6 bar Δ 1	6 bar Δ 0.5	6 bar *
1100	800	1500

* Scarico libero - Exhaust Free - Kostenlose Auspuff - Échappement libre - Escape Libre - Descarga livre.



Filettatura

IT

Gas cilindrica conforme ISO 228 Classe A.

Threads

GB

Parallel gas in conformity with ISO 228 Class A.

Gewindearten

DE

Zylindrisches Gewinde nach Norm ISO 228 Classe A.

Filetages

FR

Filetage cylindrique conforme: ISO 228 Class A.

Roscas

ES

Gas cilíndrica conforme ISO 228 Clase A.

Roscas

PT

Gas paralela conforme ISO 228 Classe A.

121

PRESA MASCHIO

MALE SOCKET
MIT AUSSENGEWINDE
COUPLEUR MÂLE
ENCHUFE MACHO
SOQUETE COM ROSCA MACHO

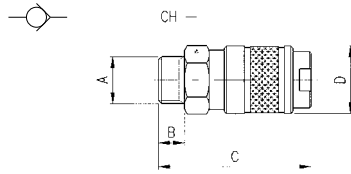

Code	A	B	C	D	CH	Pack.
00121 00 001	1/4	8	53	24	21	10
00121 00 002	3/8	9	54	24	21	10
00121 00 003	1/2	10	55	24	24	10

122

PRESA FEMMINA

FEMALE SOCKET
VERSCHLUSS-KUPPLUNG MIT INNENGEWINDE
COUPLEUR FEMELLE
ENCHUFE HEMBRA
SOQUETE COM ROSCA FÊMEA

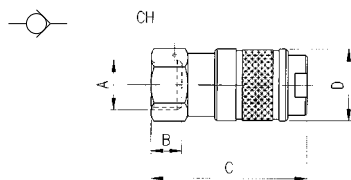

Code	A	B	C	D	CH	Pack.
00122 00 001	1/4	11	55	24	21	10
00122 00 002	3/8	11.5	55.5	24	21	10
00122 00 003	1/2	14	59	24	24	10

123

PRESA A CALZAMENTO CON MOLLA

COMPRESSION SOCKET WITH SPRING
VERSCHLUSS-KUPPLUNG MIT KNICKSCHUTZFEDER
COUPLEUR AVEC RESSORT DE PROTECTION
ENCHUFE TUBO CON MUELLE
SOQUETE COM CONEXÃO PUSH-ON COM MOLA

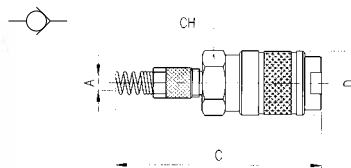

Code	A	C	D	CH	Pack.
00123 00 001	6/4	141	24	21	10
00123 00 002	8/6	146.5	24	21	10
00123 00 003	10/8	154	24	21	10

Molla Acciaio Inox AISI 304 - EN 1.4301
Stainless Steel Spring AISI 304 - EN 1.4301
Edelstahlfeder AISI 304 - EN 1.4301
Ressort Acier Inoxydable AISI 304 - EN 1.4301
Muelle Acero Inoxidable AISI 304 - EN 1.4301
Mola Aço Inoxidável AISI 304 - EN 1.4301

124

PRESA A CALZAMENTO

COMPRESSION SOCKET
VERSCHLUSS-KUPPLUNG MIT ÜBERWURFVERSCHRAUBUNG
COUPLEUR RACCORD À COIFFE
ENCHUFE TUBO
SOQUETE COM CONEXÃO PUSH-ON

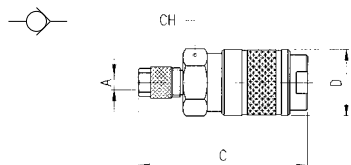

Code	A	C	D	CH	Pack.
00124 00 001	6/4	59	24	21	10
00124 00 002	8/6	59	24	21	10
00124 00 003	10/8	60	24	21	10

125

PRESA CON PORTAGOMMA A RESCA

SOCKET WITH REST FOR RUBBER HOSE
 VERSCHLUSS-KUPPLUNG MIT SCHLAUCHTÜLLE
 COUPLEUR À DOUILLE ANNELÉE POUR TUBE
 ENCHUFE EPIGA
 SOQUETE COM ESPIGÃO PARA MANGUEIRA DE BORRACHA

Code	A	C	D	CH	Pack.
00125 00 001	6	64	24	21	10
00125 00 002	8	64	24	21	10
00125 00 003	10	64	24	21	10
00125 00 004	12	64	24	21	10

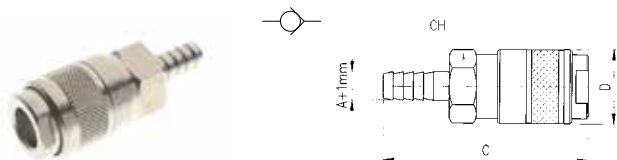

126

PRESA CON PORTAGOMMA

SOCKET FOR RUBBER HOSE
 VERSCHLUSS-KUPPLUNG FÜR GUMMISCHLAUCH
 COUPLEUR A DOUILLE POUR TUBE
 ENCHUFE CON PORTAGOMA
 SOQUETE COM ESPIGÃO PARA TUBO DE BORRACHA

Code	A	C	D	CH	Pack.
00126 00 001	14/6	72	24	21	10
00126 00 002	17/8	72	24	21	10
00126 00 003	19/10	72	24	21	10

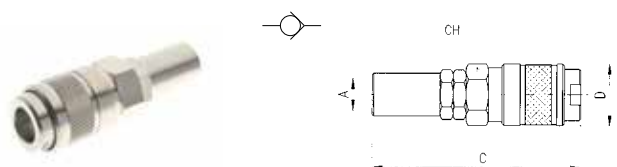

251

INNESTO MASCHIO

MALE PLUG
 STECKER MIT AUSSENGEWINDE
 EMBOUT MÂLE
 ADAPTADOR MACHO
 PLUG COM ROSCA MACHO

Code	A	B	C	CH	Pack.
00251 00 01 03 NB	1/4	8	38	17	10
00251 00 01 04 NB	3/8	9	39	19	10
00251 00 01 05 NB	1/2	10	40.5	24	10

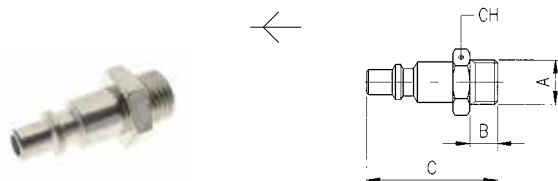

251AC

INNESTO IN ACCIAIO MASCHIO

STEEL MALE PLUG
 STECKER MIT AUSSENGEWINDE AUS STAHL
 EMBOUT MÂLE EN ACIER
 ADAPTADOR EN ACERO MACHO
 PLUG EM AÇO COM ROSCA MACHO

Code	A	B	C	CH	Pack.
251AC 00 51 03 ZI	1/4	8	38	17	10
251AC 00 51 04 ZI	3/8	9	39	19	10
251AC 00 51 05 ZI	1/2	10	40.5	24	10

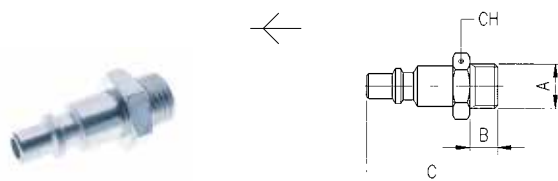

Acciaio Indurito
 Hardened Steel
 Gehärtetem Stahl
 Acier Trempé
 Acero Curtido
 Aço Endurecido

252

INNESTO FEMMINA

FEMALE PLUG
 STECKER MIT INNENGEWINDE
 EMBOUT FEMELLE
 ADAPTADOR HEMBRA
 PLUG COM ROSCA FÊMEA

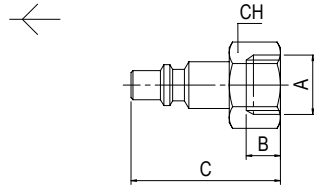

Code	A	B	C	CH	Pack.
00252 00 01 03 NB	1/4	11	38	17	10
00252 00 01 04 NB	3/8	11.5	38.5	19	10
00252 00 01 05 NB	1/2	14	41	24	10

252AC

INNESTO IN ACCIAIO FEMMINA

STEEL FEMALE PLUG
 STECKER MIT INNENGEWINDE AUS STAHL
 EMBOUT FEMELLE EN ACIER
 ADAPTADOR EN ACERO HEMBRA
 PLUG EM AÇO COM ROSCA FÊMEA

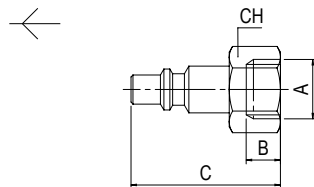

Code	A	B	C	CH	Pack.
252AC 00 51 03 ZI	1/4	11	38	17	10
252AC 00 51 04 ZI	3/8	11.5	38.5	19	10
252AC 00 51 05 ZI	1/2	14	41	24	10

Acciaio Indurito
 Hardened Steel
 Gehärtetem Stahl
 Acier Trepé
 Acero Curtido
 Aço Endurecido

253

INNESTO A CALZAMENTO CON MOLLA

COMPRESSION PLUG WITH SPRING
 STECKER MIT KNICKSCHUTZFEDER
 EMBOUT AVEC RESSORT DE PROTECTION
 ADAPTADOR TUBO CON MUELLE
 PLUG COM CONEXÃO PUSH-ON COM MOLA

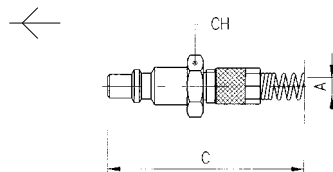

Code	A	C	CH	Pack.
00253 00 001	6/4	124.5	13	10
00253 00 002	8/6	130	13	10
00253 00 003	10/8	137.5	14	10
00253 00 004	12/10	143	16	10

Molla Acciaio Inox AISI 304 - EN 1.4301
 Stainless Steel Spring AISI 304 - EN 1.4301
 Edelstahlfeder AISI 304 - EN 1.4301
 Ressort Acier Inoxydable AISI 304 - EN 1.4301
 Muelle Acero Inoxidable AISI 304 - EN 1.4301
 Mola Aço Inoxidável AISI 304 - EN 1.4301

254

INNESTO A CALZAMENTO

COMPRESSION PLUG
 STECKER MIT ÜBERWURFVERSCHRAUBUNG
 EMBOUT À RACCORD À COIFFE
 ADAPTADOR TUBO
 PLUG COM CONEXÃO PUSH-ON

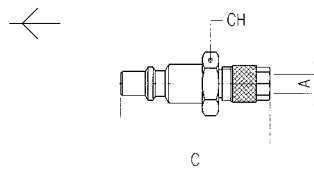

Code	A	C	CH	Pack.
00254 00 001	6/4	43.5	13	10
00254 00 002	8/6	43.5	13	10
00254 00 003	10/8	44.5	14	10
00254 00 004	12/10	46	16	10

255

INNESTO CON PORTAGOMMA A RESCA

PLUG WITH REST FOR RUBBER HOSE
 STECKER MIT SCHLAUCHTÜLLE
 EMBOUT À DOUILLE ANNELÉE POUR TUBE
 ADAPTADOR ESPIGA
 PLUG COM ESPIGÃO PARA TUBO DE BORRACHA



Code	A	C	D	Pack.
00255 00 01 X4 NB	6	44.5	12	10
00255 00 01 X7 NB	8	44.5	12	10
00255 00 01 X9 NB	10	47.5	14	10
00255 00 01 Y1 NB	12	47.5	16	10

255AC

INNESTO IN ACCIAIO CON PORTAGOMMA A RESCA

STEEL PLUG WITH REST FOR RUBBER HOSE
 STECKER MIT SCHLAUCHTÜLLE AUS STAHL
 EMBOUT À DOUILLE ANNELÉE POUR TUBE EN ACIER
 ADAPTADOR EN ACERO ESPIGA
 PLUG EM AÇOÙ COM ESPIGÃO PARA TUBO DE BORRACHA



Code	A	C	D	Pack.
255AC 00 51 X4 ZI	6	44.5	12	10
255AC 00 51 X7 ZI	8	44.5	12	10
255AC 00 51 X9 ZI	10	47.5	14	10
255AC 00 51 Y1 ZI	12	47.5	16	10

Acciaio Indurito
 Hardened Steel
 Gehärtetem Stahl
 Acier Trempé
 Acero Curtido
 Aço Endurecido

256

INNESTO CON PORTAGOMMA

PLUG FOR RUBBER HOSE
 STECKER FÜR GUMMISCHLAUCH
 EMBOUT POUR TUBE
 ADAPTADOR CON PORTAGOMA
 PLUG COM ESPIGÃO PARA TUBO DE BORRACHA

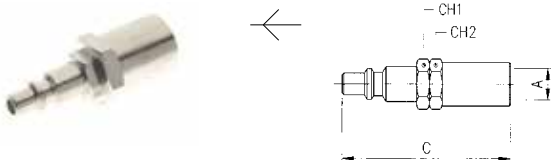

Code	A	C	CH1	CH2	Pack.
00256 00 001	14/6	60	15	17	10
00256 00 002	17/8	60	15	20	10
00256 00 003	19/10	60	15	22	10

257

INNESTO A BAIONETTA

BAYONET PLUG
 STECKER MIT BAJONETT-VERSCHLUSS
 EMBOUT À RACCORD À BAIONNETTE
 ADAPTADOR BAYONETA
 PLUG COM CONEXÃO TIPO BAIONETA

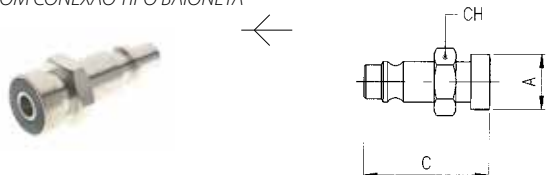

Code	A	C	CH	Pack.
00257 00 001	15	38.5	15	10

258

INNESTO A SCARICO PROGRESSIVO

PLUG WITH GRADUAL EXHAUST
 STECKER MIT PROGRESSIVER ENTLASTUNG
 EMBOUT À PASSAGE PROGRESSIF
 ADAPTADOR DE DESCARGA PROGRESIVA
 PLUG COM ESCAPE PROGRESSIVO

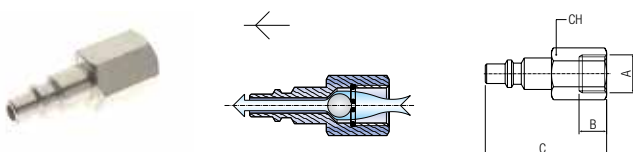

Code	A	B	C	CH	Pack.
00258 00 001	1/4	11	46.5	17	10